

### Specifications

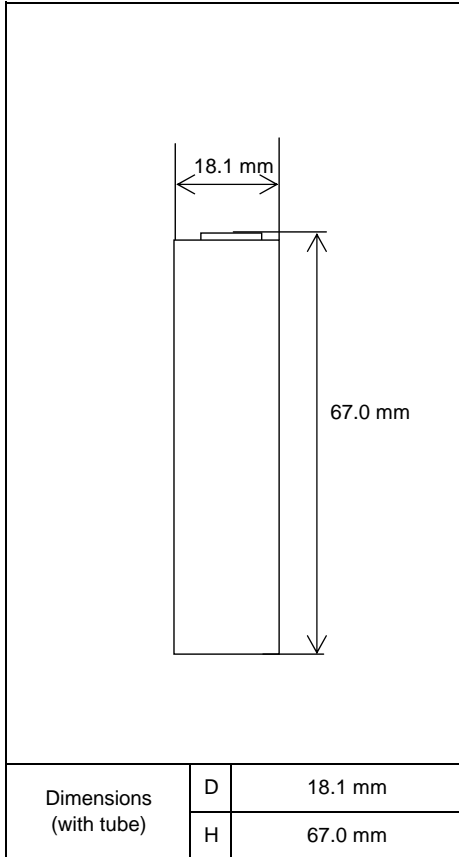

Type : Nickel-Metal Hydride Battery		Size : 4/3FA	
Capacity <sup>1)</sup>	Typical	3200mAh	
	Minimum	3050mAh	
Nominal Voltage		1.2V	
Charging Current x Time	Fast Charge <sup>2)</sup>	3200 mA x about 1.1h	
Ambient Temp.	Charge Condition	Fast Charge <sup>2)</sup>	
	Discharge Condition		
	Storage Condition	Less than 30days	0°C - 40°C
		Less than 90days	0°C - 50°C
Less than 1year		-20°C - 50°C	
Internal Impedance <sup>3)</sup> (after discharge to E.V.=1.0V)		Approx. 6mΩ(at 1000Hz)	
Weight <sup>4)</sup>		Approx. 59 g	
Size <sup>4)</sup> : (Diameter) x (Height)		18.1(D) x 67.0(H) mm	

- 1) Single cell capacity under the following condition.  
Charge : 320mA x 16h, Discharge : 640mA (E.V.=1.0V) at 20°C
- 2) Use recommended charging system.
- 3) After a few charge and discharge cycles under the above 1) condition.
- 4) With tube.

### Typical Characteristics

#### Charge

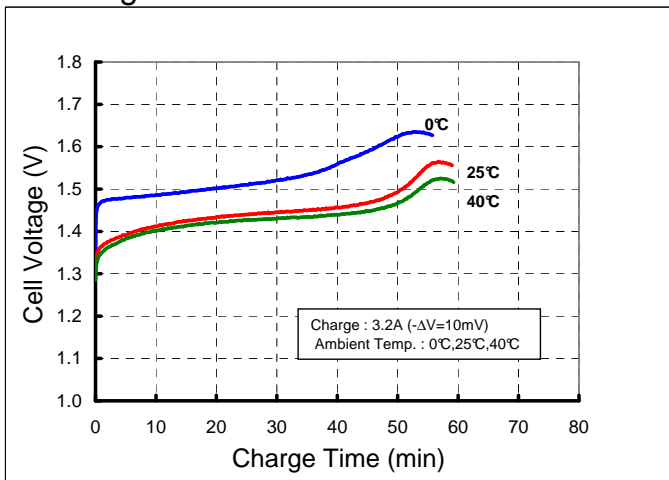

#### Discharge

